

# RT193WN Assembly Instructions

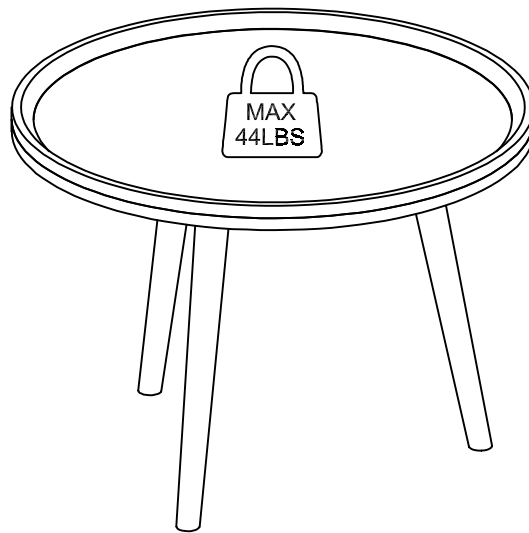

**NOTE:** Don't fully tighten the screws until the very end. Once you have fully assembled the cart, then proceed to completely tighten all the screws.

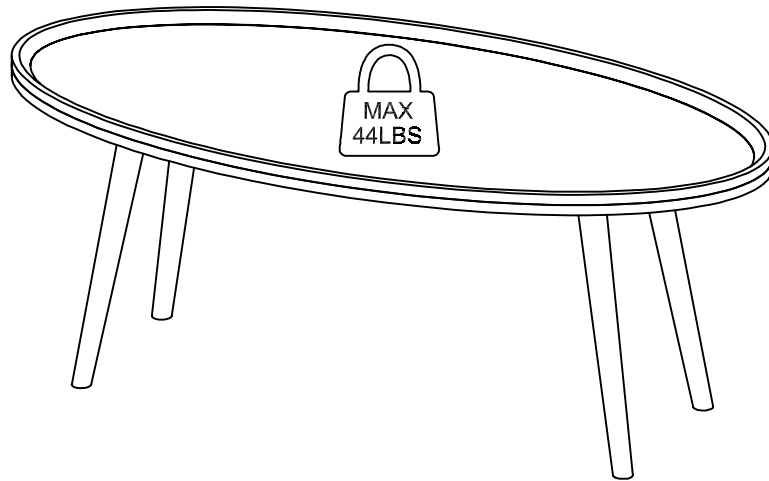
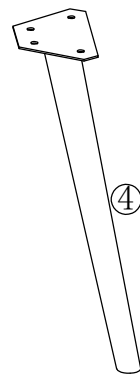
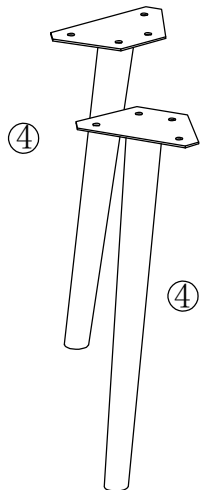
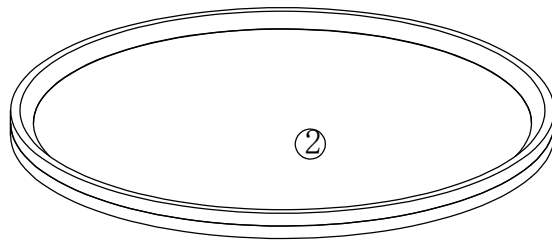
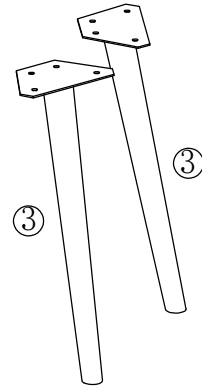
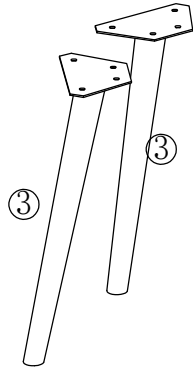
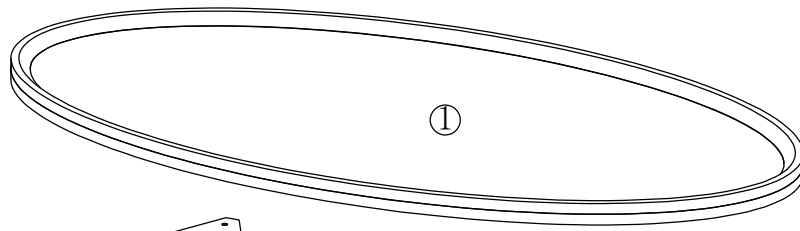

# Parts & Hardware List

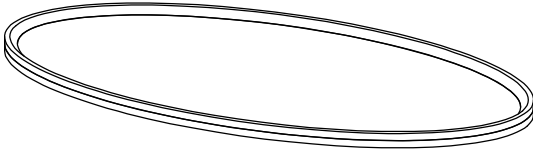

① 1PC

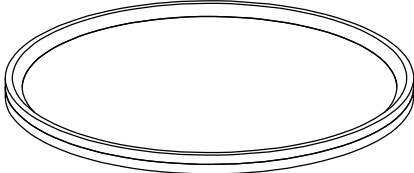

② 1PCS

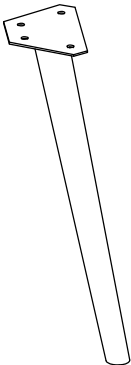

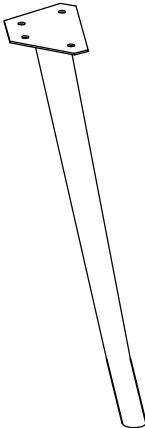

③ 4PCS



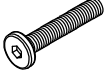

④ 3PCS

# Hardware List

A M6x12mm  28PCS	B 4mm  1PC
----------------------------------------------------------------------------------------------------------------	----------------------------------------------------------------------------------------------------------

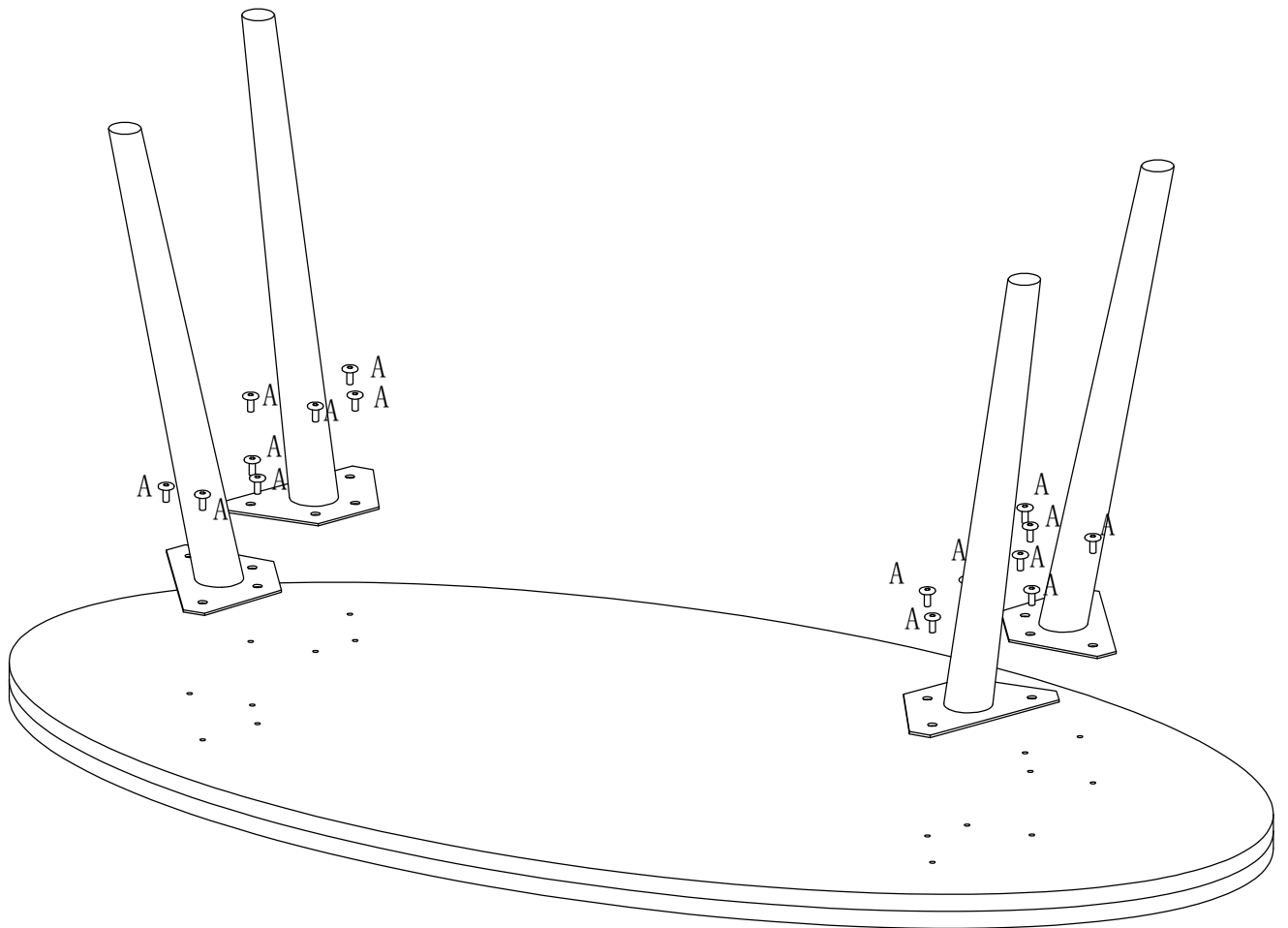
1

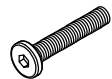



A M6x12mm  16PCS	B 4mm  1PC
----------------------------------------------------------------------------------------------------------------	----------------------------------------------------------------------------------------------------------

4OF6

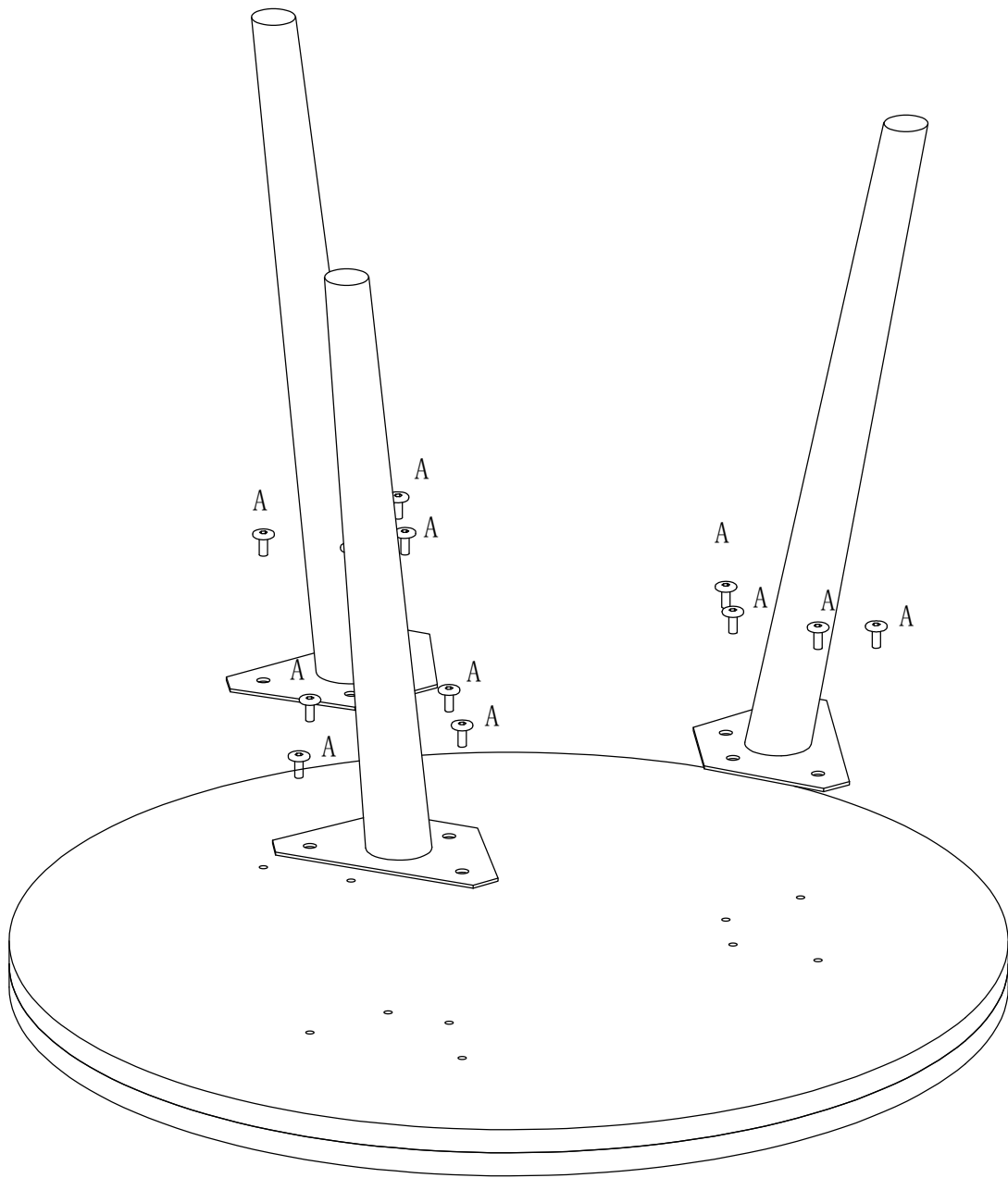
2

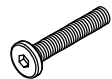

A M6x12mm  12PCS	B 4mm  1PC
----------------------------------------------------------------------------------------------------------------	----------------------------------------------------------------------------------------------------------

50F6

3

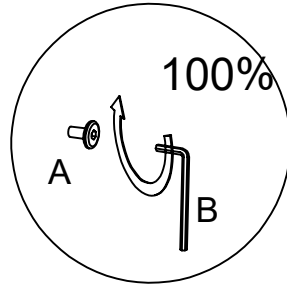

\*ALL screws tighten fully.100%

