

Assembly Instructions

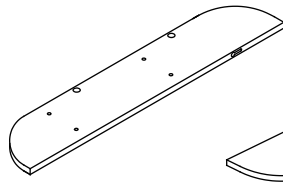

Components



A*1

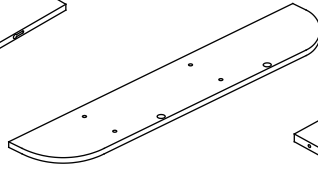

B*1

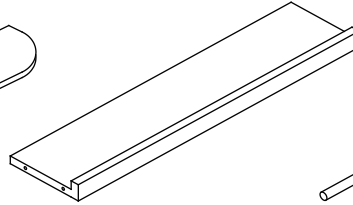

C*2

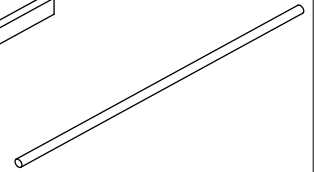

D*2

Hardware



a*2

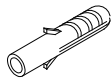

b*2



c*8



d*8

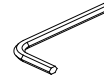

e*1



Paper Template

Sticker Sticker

Sticker*2

Weight Capacity 11 lbs

①

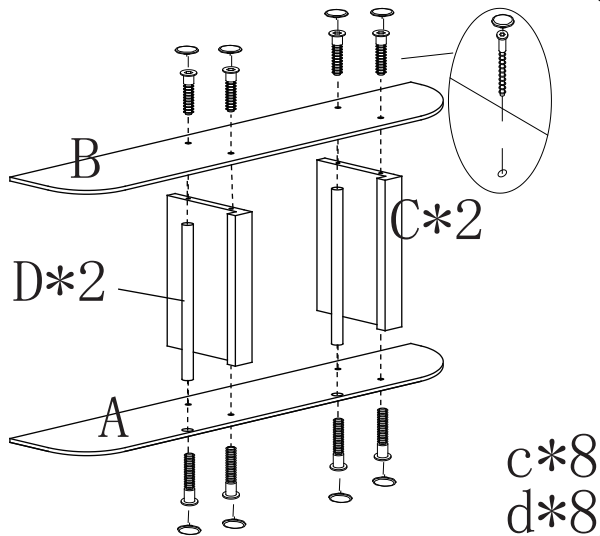

②

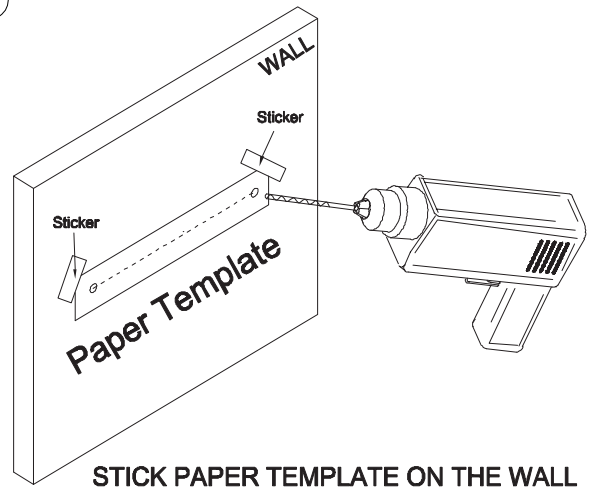

③

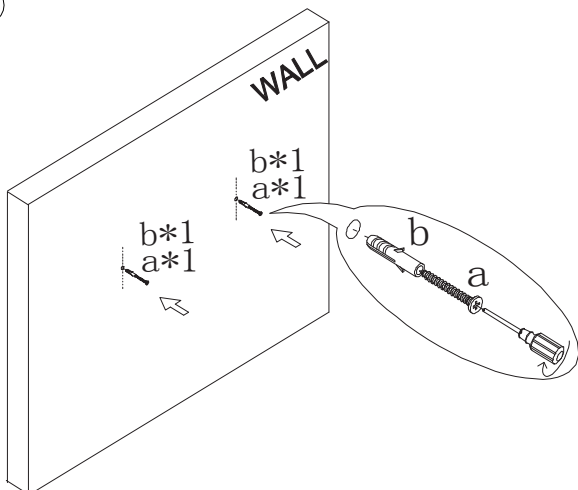

④

