

Assembly Instructions

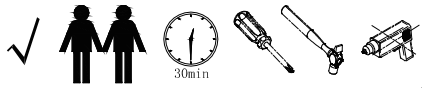

Components

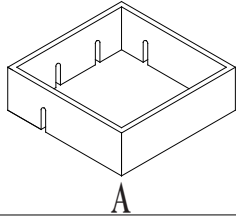

A

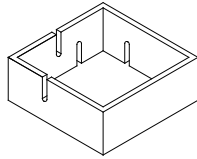

B

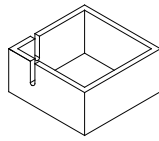

C

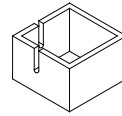

D

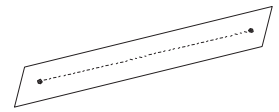

Paper Template



a*2

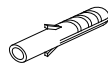

b*2

Sticker Sticker

Sticker*2

Weight Capacity

22 Ibs

1

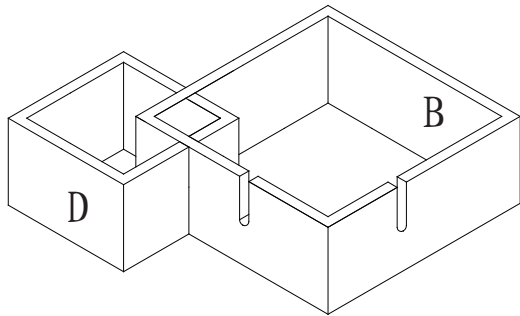

2

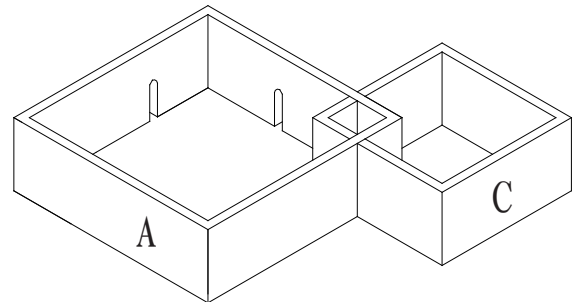

3

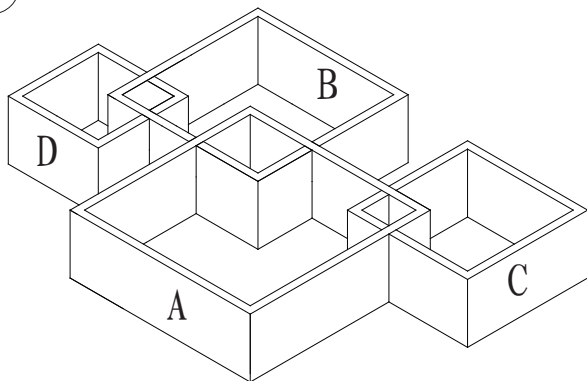

4

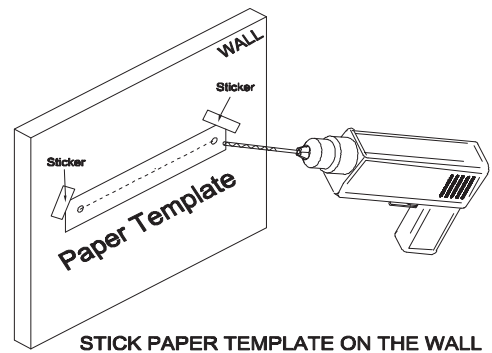

5

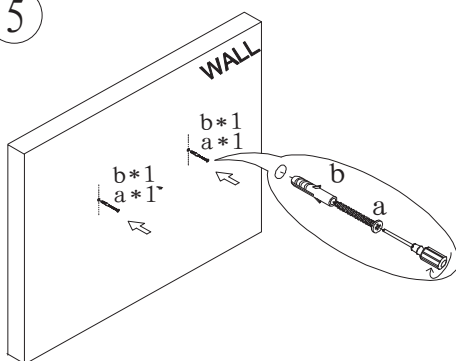

6

